

# AUTOMOTIVE RELAYS

## ET2/ET1 SERIES

### DESCRIPTION

The NEXEM ET2/ET1 series is PC-board mount type automotive relay suitable for various motor and heater control applications that require a high quality and performance. The ET2/ET1 series is the relay that succeeds fundamental structure and performance of the NEXEM EP2/EP1 series that has the high share with a motor control usage of the automobile at automobile industry in the world. Besides the ET2/ET1 series is succeeding for about 50% of miniaturization compared to ET2/ET1 series.

### FEATURES

- PC board mounting
- Approx. 50% relay volume of EP2/EP1
- Approx. 75% relay space of EP2/EP1
- Approx. 70% relay height of EP2/EP1
- Approx. 50% relay weight of EP2/EP1

### APPLICATIONS

- Motor control
- Heater control
- Solenoid control



Type ET2



Type ET1

#### **For Proper Use of Miniature Relays**

##### **DO NOT EXCEED MAXIMUM RATING**

Do not use relay under excessive conditions such as over ambient temperature, over voltage and over current. Incorrect use could result in abnormal heating and damage to the relay or other parts.

##### **READ CAUTIONS IN THE SELECTION GUIDE**

Read the cautions described in EM Devices' "Miniature Relays" before dose designing your relay applications.

The information in this document is subject to change without notice.

© EM Devices Corporation 2018



- All specifications in this catalog and production status of products are subject to change without notice. Prior to the purchase, please contact EM Devices for updated product data.
- Please request for a specification sheet for detailed product data prior to the purchase.
- Before using the product in this catalog, please read "NOTE ON CORRECT USE" in "Miniature Relays selection guide" catalog.

SCHEMATIC (BOTTOM VIEW)

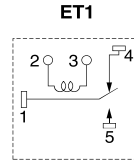
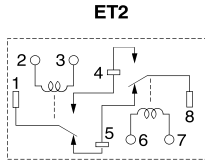

DIMENSIONS mm (inch)

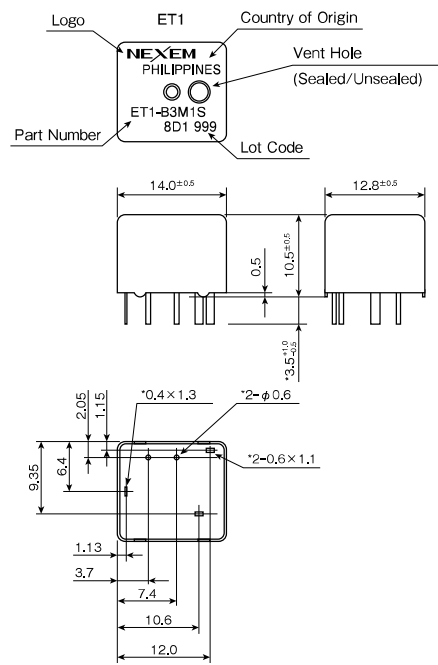
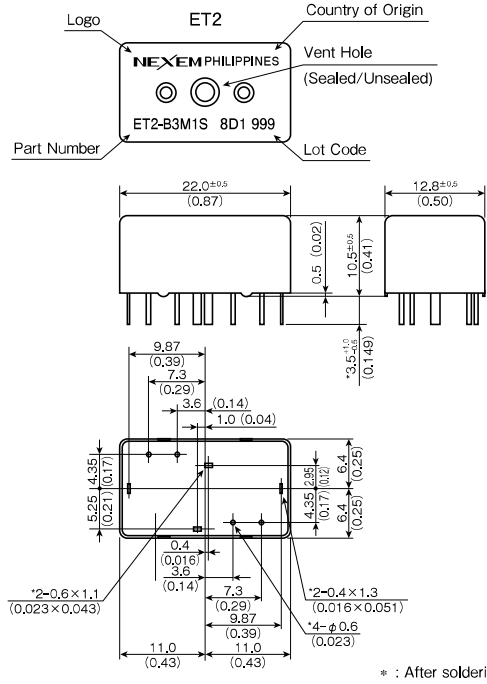

PCB PAD LAYOUT mm (inch) (BOTTOM VIEW)

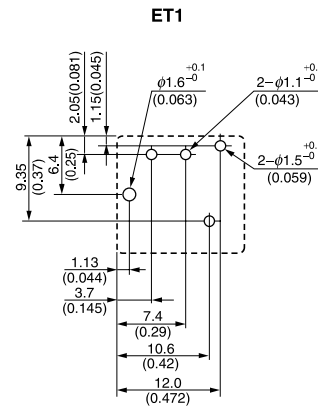
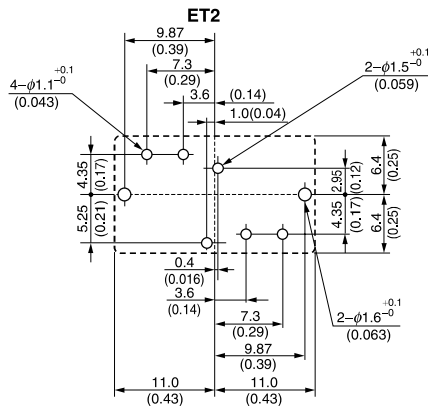

- All specifications in this catalog and production status of products are subject to change without notice. Prior to the purchase, please contact EM Devices for updated product data.
- Please request for a specification sheet for detailed product data prior to the purchase.
- Before using the product in this catalog, please read "NOTE ON CORRECT USE" in "Miniature Relays selection guide" catalog.

**SPECIFICATIONS**

(Ambient temperature:20°C)

Items		Types	
		Twin	Single
		ET2-B3M1/ET2-B3M1S	ET1-B3M1/ET1-B3M1S
Contact Form		1 Form c × 2 (H Bridge)	
Contact Rating	Maximum Switching Voltage	16 VDC	
	Maximum Switching Current	25 A (at 16 VDC)	
	Minimum Switching Current	1 A (at 5 VDC)	
	Contact Resistance	4 mΩ typical (measured at 7 A) Initial	
Contact Material		Silver oxide complex alloy	
Operate Time (Excluding Bounce)		2.5 ms typical (at Nominal Voltage) Initial	
Release Time (Excluding Bounce)		3 ms typical (at Nominal Voltage, with diode) Initial	
Nominal Operate Power		640 mW	
Insulation Resistance		100 MΩ at 500 VDC	
Breakdown Voltage	Between Open Contact	500 VAC min. (for 1 minute)	
	Between Coil and Contact	500 VAC min. (for 1 minute)	
Shock Resistance	Misoperation	98 m/s <sup>2</sup>	
	Destructive Failure	980 m/s <sup>2</sup>	
Vibration Resistance	Misoperation	10 – 300 Hz, 43 m/s <sup>2</sup>	
	Destructive Failure	10 – 500 Hz, 43 m/s <sup>2</sup> 200 hour	
Ambient Temperature		–40 to +85 °C (–40 to +185 °F)	
Coil Temperature Rise		70 °C (158 °F)/W	
Running Specification	Non-load	1 × 10 <sup>6</sup> operations	
	Load	Power Window Motor (14 V, 20 A, Locked)	100 × 10 <sup>3</sup> operations
		Power Window Motor (14 V, 20 A /3 A, Unlocked)	100 × 10 <sup>3</sup> operations
Weight		Approx. 7.5 g (0.26 oz)	Approx. 4.5 g (0.16 oz)

**COIL RATING**

**SEALED TYPE**

(Ambient temperature:20°C)

Contact Form		Part Number	Nominal Voltage (VDC)	Coil Resistance (Ω±10%)	Must Operate Voltage (VDC)	Must Release Voltage (VDC)
Twin	1 Form c × 2	ET2-B3M1S	12	225	6.5	0.9
Single	1 Form c	ET1-B3M1S				

**UNSEALED TYPE**

(Ambient temperature:20°C)

Contact Form		Part Number	Nominal Voltage (VDC)	Coil Resistance (Ω±10%)	Must Operate Voltage (VDC)	Must Release Voltage (VDC)
Twin	1 Form c × 2	ET2-B3M1	12	225	6.5	0.9
Single	1 Form c	ET1-B3M1				



- All specifications in this catalog and production status of products are subject to change without notice. Prior to the purchase, please contact EM Devices for updated product data.
- Please request for a specification sheet for detailed product data prior to the purchase.
- Before using the product in this catalog, please read "NOTE ON CORRECT USE" in "Miniature Relays selection guide" catalog.

NUMBERING SYSTEM

**ET2-B3M1S**

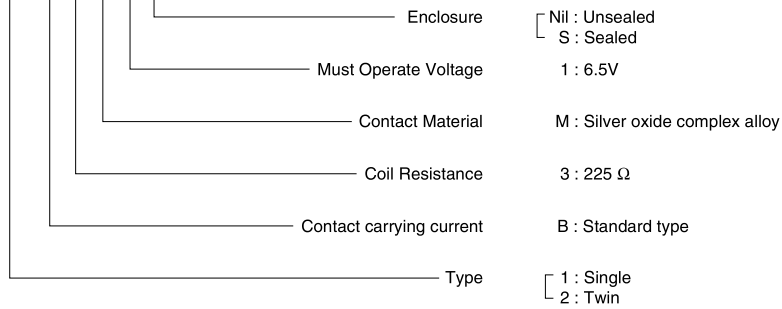

COIL TEMPERATURE RISE

Test piece : ET1-B3M1S

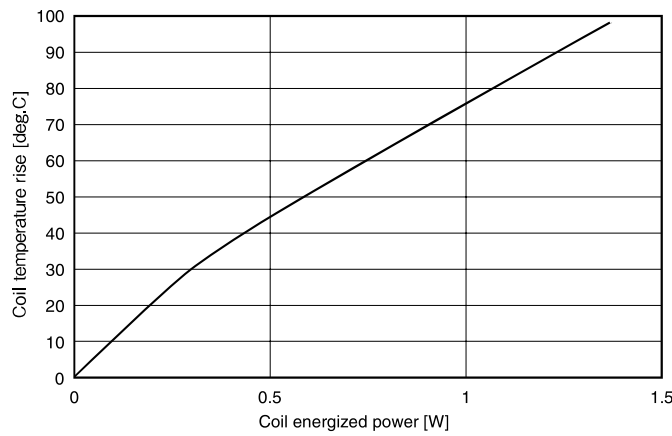
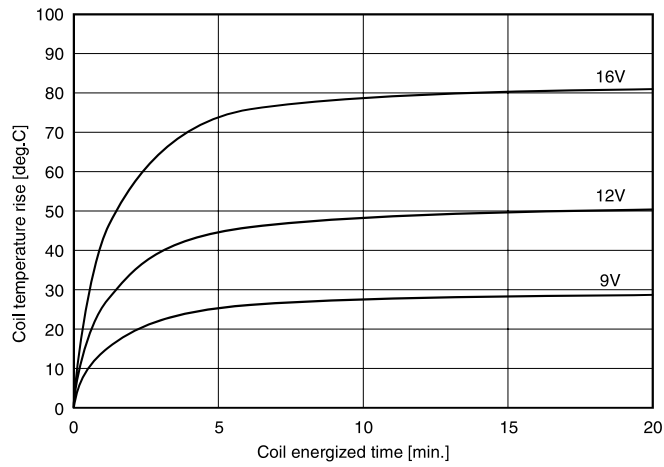

- All specifications in this catalog and production status of products are subject to change without notice. Prior to the purchase, please contact EM Devices for updated product data.
- Please request for a specification sheet for detailed product data prior to the purchase.
- Before using the product in this catalog, please read "NOTE ON CORRECT USE" in "Miniature Relays selection guide" catalog.

RELAY CHARACTERISTICS DISTRIBUTION (INITIAL)

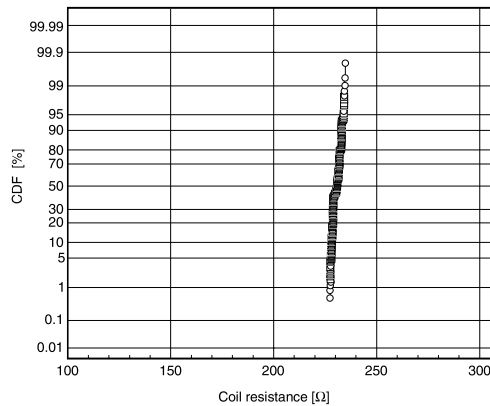
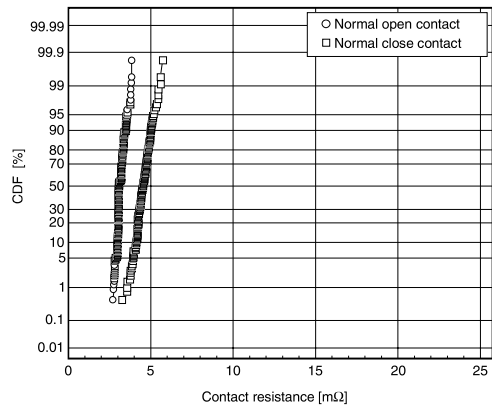
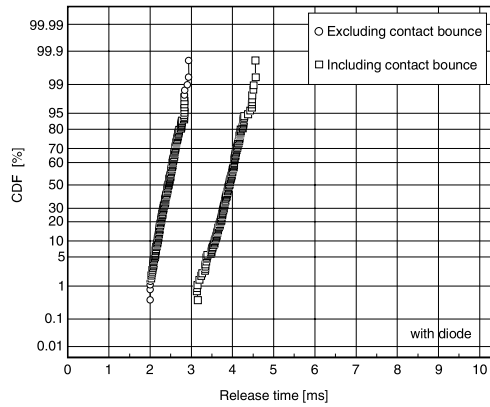
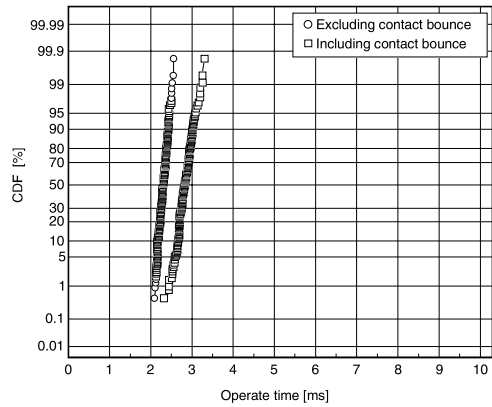
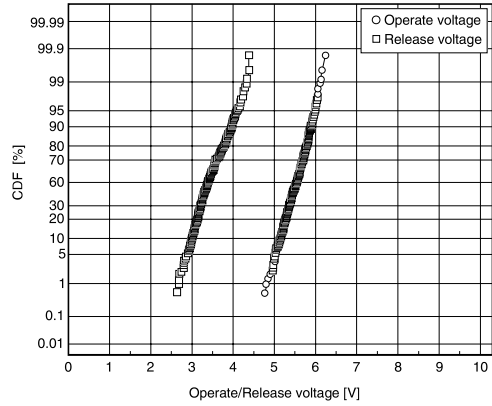

- All specifications in this catalog and production status of products are subject to change without notice. Prior to the purchase, please contact EM Devices for updated product data.
- Please request for a specification sheet for detailed product data prior to the purchase.
- Before using the product in this catalog, please read "NOTE ON CORRECT USE" in "Miniature Relays selection guide" catalog.

**DURABILITY LIFE**

Mechanical life test

- Ambient temperature : 20 °C
- Frequency : 15 Hz (50 % duty)
- Contact load : No load
- Number of operations :  $10 \times 10^6$
- Samples : ET2-B3M1S 10 pieces

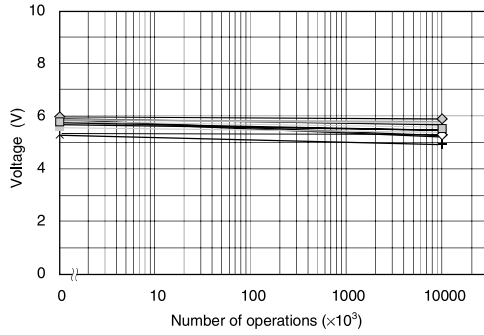

**Operate Voltage**

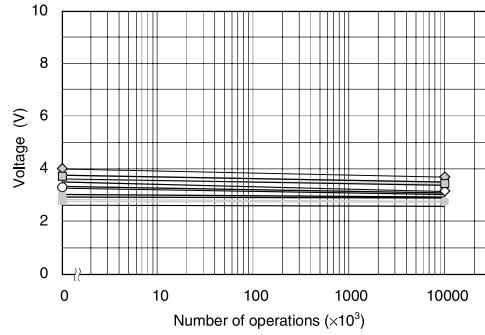

**Release Voltage**

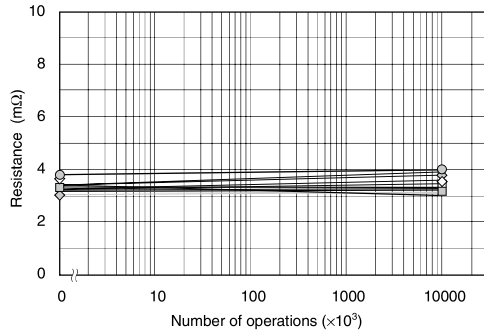

**Contact Resistance (N.O contact)**

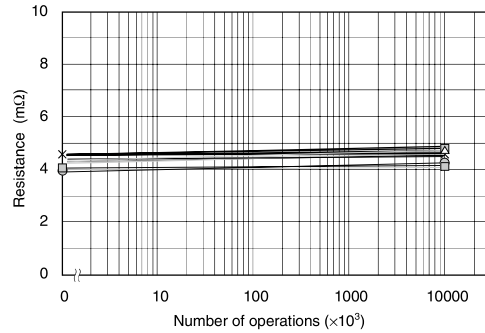

**Contact Resistance (N.C contact)**

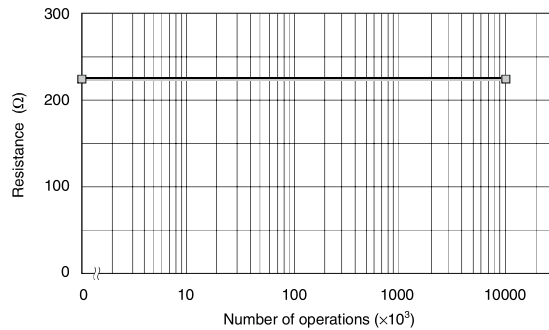

**Coil Resistance**



● All specifications in this catalog and production status of products are subject to change without notice. Prior to the purchase, please contact EM Devices for updated product data.  
 ● Please request for a specification sheet for detailed product data prior to the purchase.  
 ● Before using the product in this catalog, please read "NOTE ON CORRECT USE" in "Miniature Relays selection guide" catalog.

Electrical life test (1)

- Ambient temperature : 20 °C
- Frequency : 0.2s ON/9.8s OFF, 0.1 Hz
- Contact load : 14 VDC, 20A, Power window motor load, locked
- Number of operations :  $100 \times 10^3$
- Samples : ET2-B3M1S 10 pieces

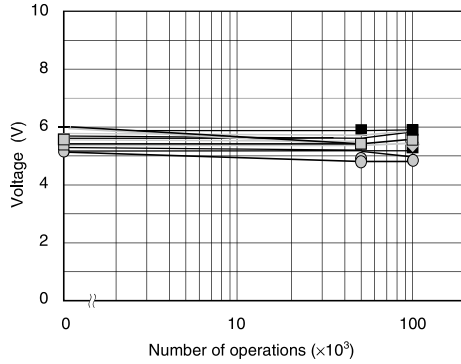

**Operate Voltage**

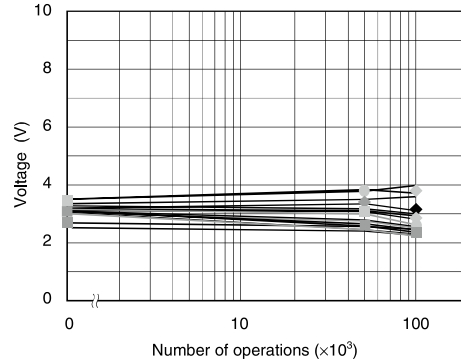

**Release Voltage**

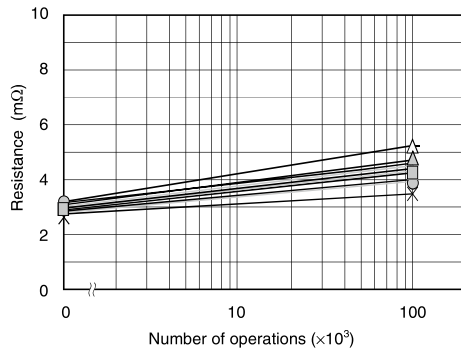

**Contact Resistance (N.O contact)**

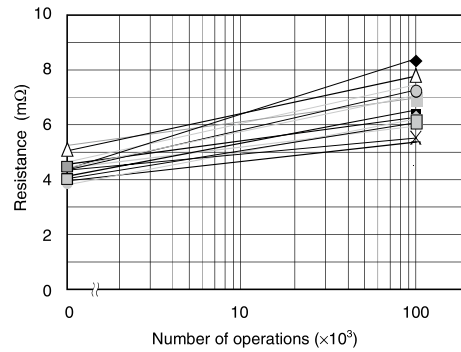

**Contact Resistance (N.C contact)**

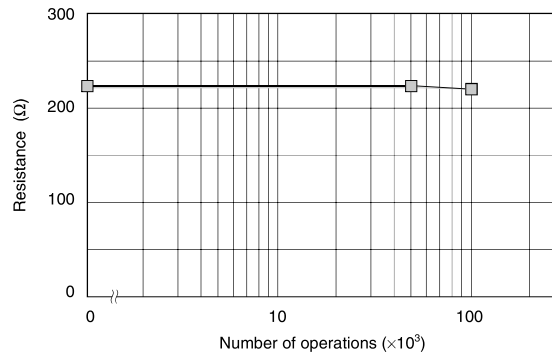

**Coil Resistance**



●All specifications in this catalog and production status of products are subject to change without notice. Prior to the purchase, please contact EM Devices for updated product data.  
 ●Please request for a specification sheet for detailed product data prior to the purchase.  
 ●Before using the product in this catalog, please read "NOTE ON CORRECT USE" in "Miniature Relays selection guide" catalog.

Electrical life test (2)

- Ambient temperature : 20 °C
- Frequency : 0.2s ON/9.8s OFF, 0.1 Hz
- Contact load : 14 VDC, 20A, Power window motor load, Unlocked
- Number of operations :  $100 \times 10^3$
- Samples : ET2-B3M1S 10 pieces

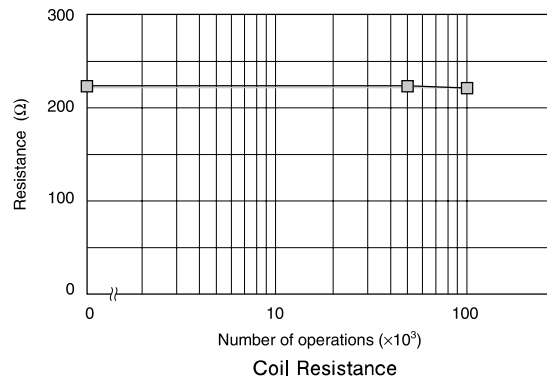
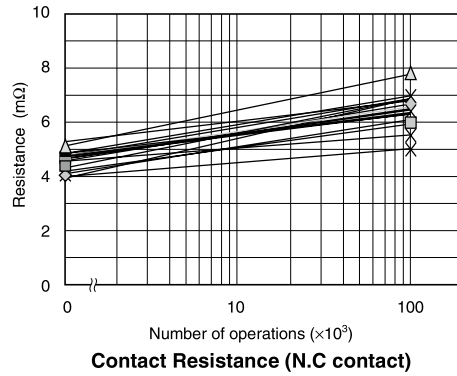
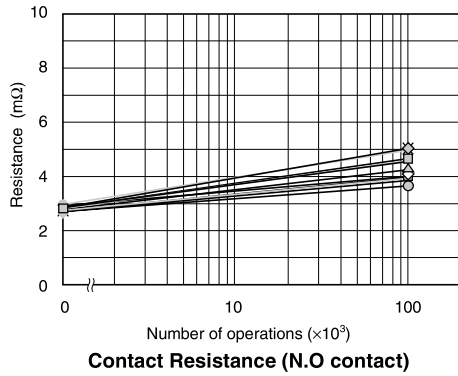
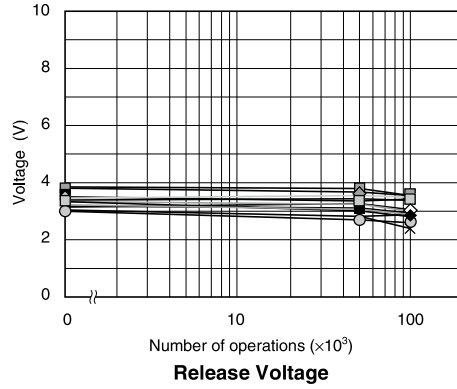
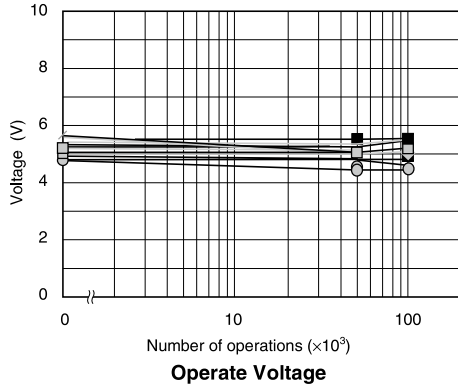

●All specifications in this catalog and production status of products are subject to change without notice. Prior to the purchase, please contact EM Devices for updated product data.  
 ●Please request for a specification sheet for detailed product data prior to the purchase.  
 ●Before using the product in this catalog, please read "NOTE ON CORRECT USE" in "Miniature Relays selection guide" catalog.



No part of this document may be copied or reproduced in any form or by any means without the prior written consent of EM Devices Corporation. EM Devices Corporation assumes no responsibility for any errors which may appear in this document.

EM Devices Corporation does not assume any liability for infringement of patents, copyrights or other intellectual property rights of third parties by or arising from use of a device described herein or any other liability arising from use of such device. No license, either express, implied or otherwise, is granted under any patents, copyrights or other intellectual property rights of EM Devices Corporation or others.

The possibility of defects cannot be eliminated entirely even though EM Devices Corporation has been making continuous effort to enhance the reliability of its electronic components. To minimize risks of damage or injury to persons or property arising from a defect in an EM Devices electronic component, customers must incorporate sufficient safety measures in its design, such as redundancy, fire-containment, and anti-failure features. EM Devices products are classified into the following three quality grades:

"Standard," "Special," and "Specific". Specific quality grade applies only to devices developed based on a customer designated quality assurance program for a specific application. The recommended applications of a device depend on its quality grade, as indicated below. Customers must check the quality grade of each device before using it in a particular application.

Standard: Computers, office equipment, communications equipment, test and measurement equipment, audio and visual equipment, home electronic appliances, machine tools, personal electronic equipment and industrial robots

Special: Transportation equipment (automobiles, trains, ships, etc.), traffic control systems, anti-disaster systems, anti-crime systems, safety equipment and medical equipment (not specifically designed for life support)

Specific: Aircrafts, aerospace equipment, submersible repeaters, nuclear reactor control systems, life support systems or medical equipment for life support, etc.

The quality grade of EM Devices products are considered as Standard, unless otherwise specified in EM Devices Data Sheets or Data Books. If customers intend to use EM Devices products for applications that are not specified at Standard quality grade, they should contact an EM Devices sales representative in advance.

(Note)

- (1) "EM Devices" as used in this statement means EM Devices Corporation and also includes its majority owned subsidiaries.
- (2) "EM Devices electronic component products" means any electronic component product developed or manufactured by or for EM Devices (as defined above).



- All specifications in this catalog and production status of products are subject to change without notice. Prior to the purchase, please contact EM Devices for updated product data.
- Please request for a specification sheet for detailed product data prior to the purchase.
- Before using the product in this catalog, please read "NOTE ON CORRECT USE" in "Miniature Relays selection guide" catalog.